

Data Sheet



Article number: 0108049

Description: Retaining ring JK 32 DIN 984

Measures

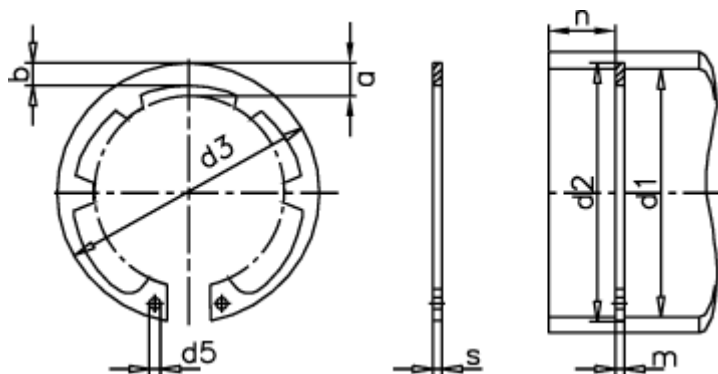

a max	= 5.1	FN kN	= 14.6	s	= 1.20
AN mm ²	= 87.9	FRg kN	= 4.7	t	= 0.85
b	= 3.3	FR kN	= 13.8	tol	= +0,25
d1	= 32	g	= 1.0	tol	= -0.06
d2	= 33.7	K kN-mm	= 26.6	tol	= +0,50-0,25
d3	= 34.4	m min	= 1.30	Tong	= ZGJ-2
d5 min	= 2.5	Nominal drive	= 2.5	Weight kg/1000	= 2.50
Description	= JK 32	Number of serrations	= 6		